

Installation Guide for
Phase One
iXG Camera

Developed for Phase One
Cultural Heritage, Scientific and
Industrial Imaging Solutions

PHASE**ONE**
INDUSTRIAL

Installation Guide for

Phase One iXG Camera

Developed for Phase One
Cultural Heritage, Scientific and
Industrial Imaging Solutions

As new features are introduced through firmware updates, we change the downloadable version of this document, which is available from the Download sections of www.industrial.phaseone.com and www.phaseone.com

Contents

1. What's in the Box?.....	6
Optional Accessories.....	6
2. Overview.....	7
iXG Camera Parts.....	7
3. Mounting/Dismounting a Lens.....	8
Dismounting a Lens from the iXG Camera.....	9
Mounting a Lens on the iXG Camera.....	10
4. Connecting Peripherals.....	11
Attaching the Camera to a Copy stand.....	11
Camera Remote Triggering.....	14
Connecting the Remote Shutter Trigger.....	14
Connecting a Foot Pedal.....	15
Connecting Flash Sync Cable.....	16
Connecting the Power Supply.....	17
Connecting a USB 3.0 Cable to a Computer.....	18
5. Installing Capture One.....	19
Activating Capture One.....	19
Activating Capture One CH for Mac.....	19
Activating Capture One PRO for Mac.....	21
Activating Capture One DB for Mac.....	23
Activating Capture One Pro/DB for Windows.....	24
Starting a Tethered Session.....	27
Selecting Next Capture Adjustments.....	28
Selecting Camera Controls and Settings.....	29
Working with Live View.....	29
6. Capturing Images.....	32
Shooting a Test Shot.....	32
Evaluating Your Shot.....	32
Setting White Balance.....	33
7. Video Display.....	34
Activating HDMI Video Output.....	34
Configuring HDMI Control.....	35
Configuring HDMI Mode.....	36
Selecting HDMI Crop.....	36
Selecting Video Exposure Mode.....	37
Adjusting Lightness.....	37
Adjusting ISO.....	38
Adjusting Exposure Time.....	39
8. Firmware.....	40
Checking the Camera Firmware Version.....	40
About the Phase One Firmware Updater Application.....	41
Installing the Firmware Updater Application.....	42
Mac.....	42
Windows.....	42
Updating the iXG Camera Firmware.....	42
Restoring the iXG Camera Firmware.....	45

1. What's in the Box?

- Phase One iXG camera
- Schneider Kreuznach RS 72mm/ f5.6 Lens
- ø40.5mm threaded adapter ring for 72mm lens
- Collapsible ø40.5mm lens shade for 72mm
- 24 V DC power supply with international outlet adapters, 5m
- USB 3.0 cable, 3m
- Flash sync cable, 5m
- Hand release unit with 30cm cable
- Hand release trigger cable, 5m
- iXG L-shaped camera mount adapter
- Screwdriver, Allen 4mm
- Microfiber Cloth
- USB drive with documentation
- Installation Guide
- Warranty certificate
- Suitcase for iXG camera

Optional Accessories

- Schneider Kreuznach RS 120mm/ f5.6 APO Macro lens
- Collapsible ø46mm lens shade for 120mm lens

2. Overview

The iXG cameras are integrated into a Cultural Heritage digitization system offering high resolution capturing capabilities with the Phase One image capture and processing software, Capture One CH.

This iXG Installation Guide guides you through the required procedures for installing the iXG cameras.



iXG Camera Parts

1. Lens locking lever
2. HDMI port cover
3. Top Universal 3/8" threaded mount and registration holes
4. Bottom Universal 3/8" threaded mount and registration holes
5. Play button
6. Menu button
7. USB 3.0 port
8. Data terminal A
9. Data terminal B
10. Power terminal
11. Video button
12. Setup button



3. Mounting/Dismounting a Lens

NOTE: Before mounting or dismounting a lens, ensure that the power cable is not attached to the camera.

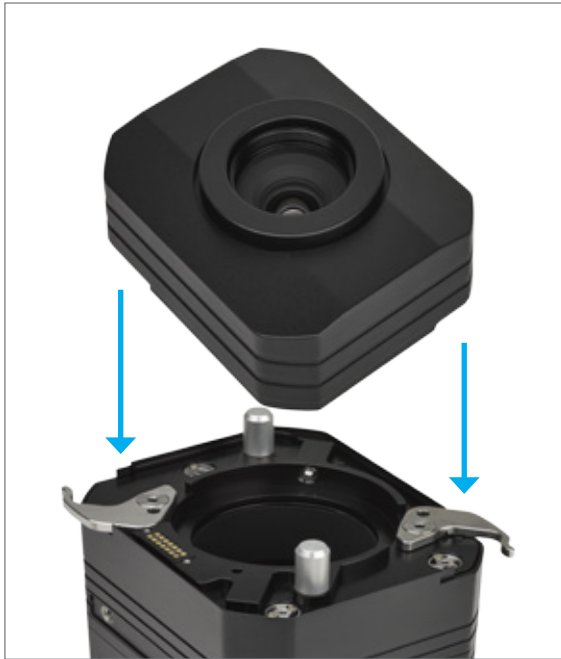

Dismounting a Lens from the iXG Camera

Lenses on the iXG series of cameras are easily dismounted.

Note: Ensure that you only dismount lenses in a clean environment. Place the detached lens on a soft cloth on the table to avoid scratching the lens.

To dismount the lens:

1. Release the lens' locking levers.



2. Remove the lens by pulling it gently away from the camera.

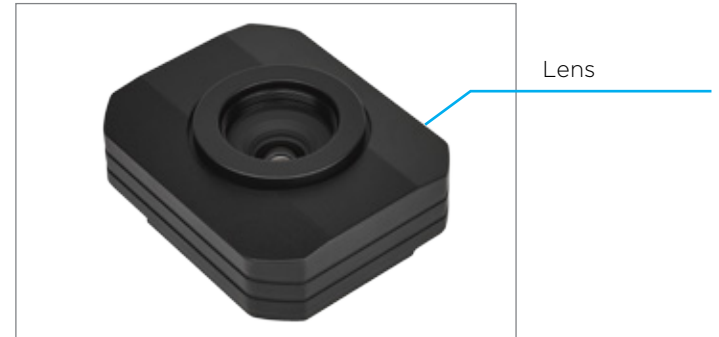

Note: If no lens is being mounted, ensure that the camera is stored in a way to protect it from dust, moisture and other damage. When the iXG camera is mounted facing down always make sure (double check) that the lens is well secured by having the lens locking levers engaged.

Mounting a Lens on the iXG Camera

Lenses of the iXG cameras are easily mounted.

Note:

- Ensure that you only mount lenses in a clean environment.
- Place a soft cloth down on the table to avoid scratching the lens.
- Ensure that you remove the rear lens cap (if attached) before mounting the lens.

To Mount a lens:

1. Place the Lens over the iXG camera body and guide it into position against the camera body using the two large positioning pins.

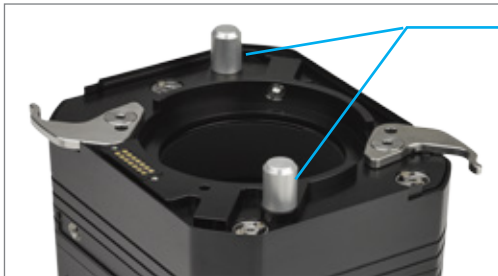

Two Positioning Pins

2. Close the Lens locking levers.



Lens Locking Lever

Note: The Lens is a-symetrical, and can only be fitted in ONE position.

4. Connecting Peripherals

This section describes the different peripheral devices, which can optionally be connected to the iXG camera.

Attaching the iXG camera to a copy stand



1. If not already attached, use the supplied 4mm Allen screwdriver to attach the L-bracket to the iXG camera by its two (hidden) screws.



L Bracket

Hidden Screws

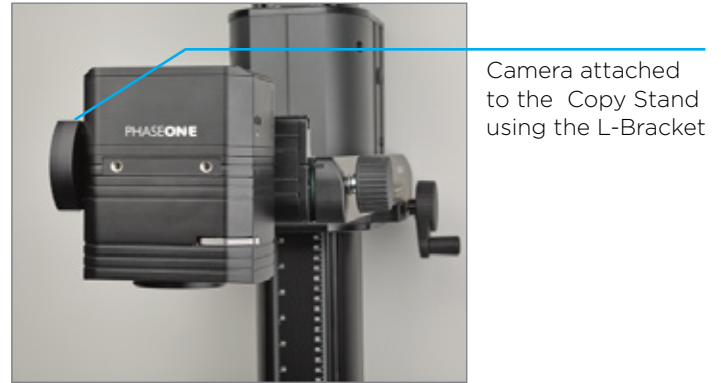

Note: The L-bracket allows the camera to be attached in either "portrait" or "landscape" position.

2. Fasten the Copy stand main screw to the L-Bracket.

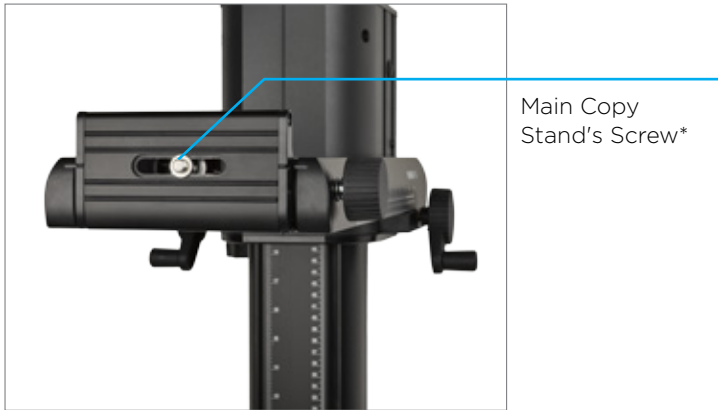

* (3/8" or 1/4" thread with an adapter)

Camera Remote Triggering

The iXG camera can be triggered by the following options:

- Remote Shutter Trigger
- Foot Pedal

Connecting the Remote Shutter Trigger

The **Remote Shutter Trigger** is used to remotely trigger the iXG camera. Use the 5-meter trigger cable to connect the Hand release trigger with 30cm cable to the iXG camera.

To connect the Remote Shutter Trigger:

1. Connect the LEMO-of the iXG 5 meter trigger cable to one of the data terminals of the iXG camera.



2. Connect the 30 cm cable to the Hand Release Trigger
3. Connect the other end (female Audio connector) of the iXG Hand Release Trigger cable to the 3.5 mm male audio jack of the 30 cm cable.

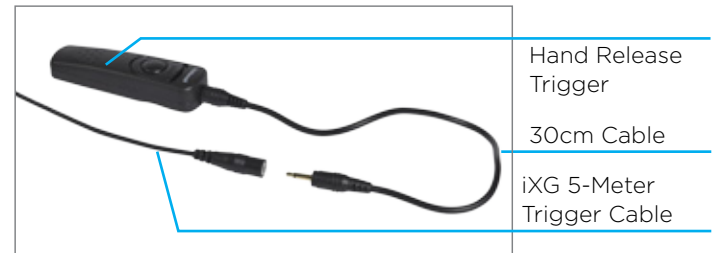

Connecting a Foot Pedal

The **Foot pedal** is used to remotely trigger the iXG camera. Use the 5 meter trigger cable to connect a Foot pedal unit to the iXG camera

To Connect a iXG Foot Pedal:

1. Connect the LEMO-of the iXG trigger cable to one of the data terminals of the iXG camera.
2. Connect the other end (female Audio Connector) of the iXG hand release trigger cable to the 3.5 mm male audio jack of the foot pedal.

Connecting Flash Sync Cable

The Flash Sync Cable is used to trigger a Flash device (a generator or a wireless transmitter).

To connect the Flash sync cable:

1. Connect the Lemo connector of the Flash sync cable to one of iXG camera's data terminals.
2. Connect the cable's other end (Audio connector) to the Flash device.



LEMO Connector

Audio Connector

Connecting the Power Supply

To connect the camera to the iXG power supply:

- Connect the Lemo connector of the iXG power cable to the power terminal of the iXG camera.

Note: When not in use, always disconnect the power from the iXG camera.



Power Input



Power Supply

Connecting a USB 3.0 Cable to a Computer

Connecting iXG to a computer using a USB 3.0 cable:



1. Insert the end of the USB 3.0 cable to the USB 3.0 port of the camera.
2. Connect the other end of the USB 3.0 cable to the USB port of your computer.

Note: Make sure you are using the computer's USB 3.0 port.

5. Installing Capture One Activating Capture One

The following section provides the required procedures to activate Capture One application.

Activating options include:

- Activating Capture One CH for Mac
- Activating Capture One Pro for Mac
- Activating Capture One DB for Mac
- Activating Capture One Pro/DB for Windows

Note: Ensure that you have an Internet connection to activate Capture One (CH).

Activating Capture One CH for Mac

To activate Capture One CH for Mac:

1. Launch the software from the Finder and IMMEDIATELY press and hold the "C" key.
2. You should then see the COCH activation screen with the 3 options "Try, Buy or Activate".

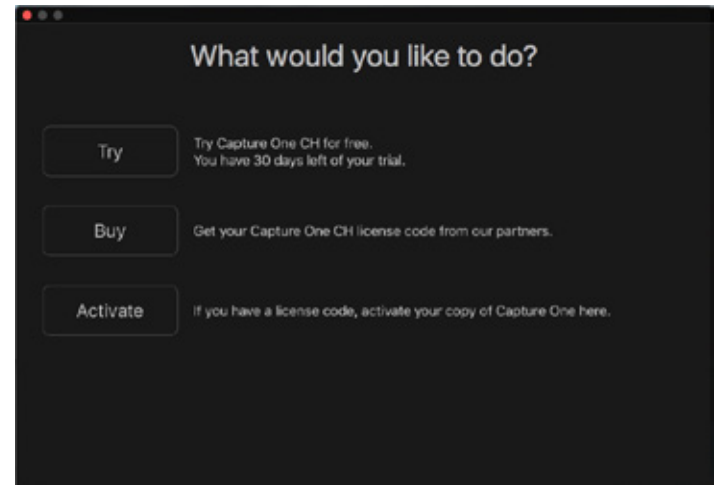

3. Press Activate.
4. It may take a few tries just to get the timing right. Repeat steps 1-2 as needed.

Note: If you already have a running, licensed version of Capture One PRO, you need to de-activate it before you perform the above (see **Activating Capture One Pro for Mac**).

The License dialog opens.

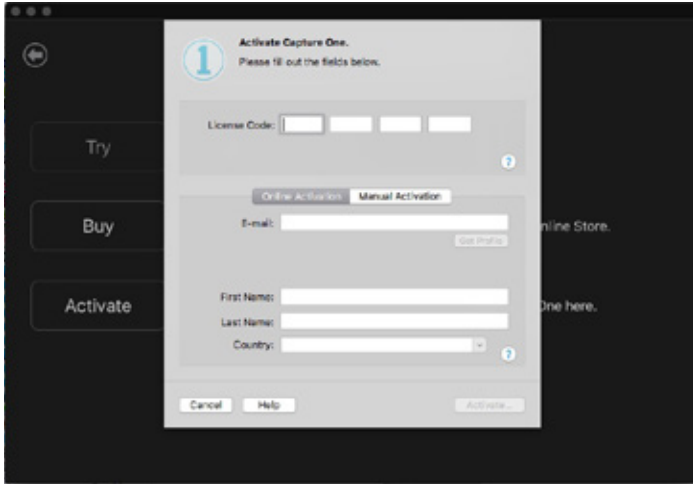

5. Enter the Capture One CH license key you were provided with by your Phase One CH partner and enter your email address that is used in your Phase One user profile, then press Get Profile.
6. Click Activate License. Your license is validated by Phase One's Activation Server.

Your software is now activated and ready for use.

Activating Capture One PRO for Mac

To activate Capture One Pro for Mac:

1. From the Capture One 10 menu, select **License**.

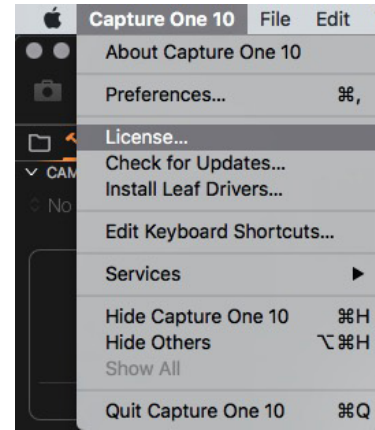

The following message appears:

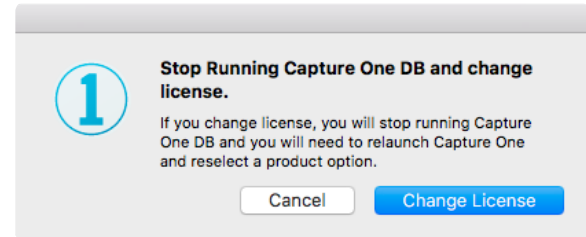

2. Click Change Licence.
Capture One application is closed.

3. Relaunch Capture One, and click Pro.

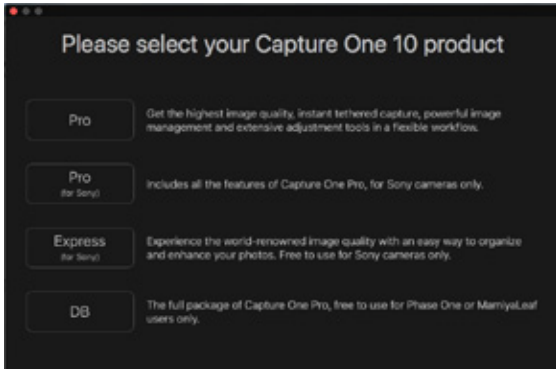

The **Activation Capture One** window appears.

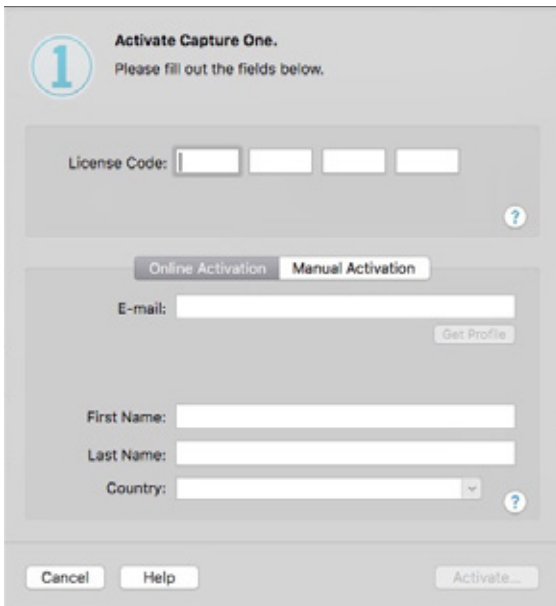

4. Enter your Capture One PRO license key and your e-mail address provided for your Phase One user profile, and click **Get Profile**.

5. Click **Activate**. Your license is validated by Phase One's Activation Server.

Your software is now activated and ready for use.

Activating Capture One DB for Mac

To activate Capture One DB for Mac:

1. From the Capture One 10 menu, select **License**.

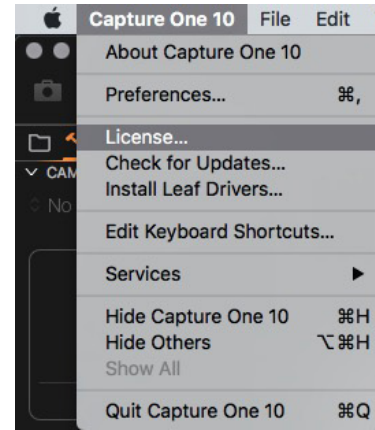

The following message appears:

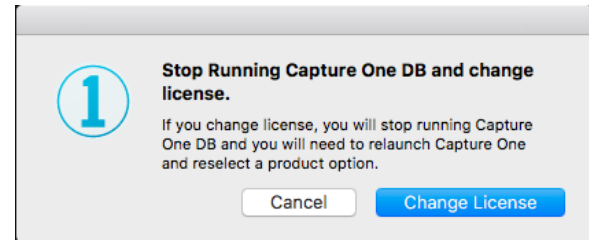

2. Click Change Licence.

Capture One application is closed.

3. Relaunch Capture One, and select **DB**.

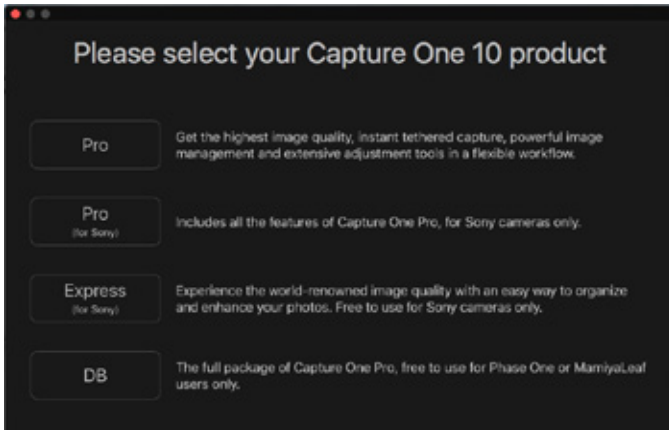

Activating Capture One Pro/DB for Windows

To activate Capture One Pro for Windows:

1. In the Help menu, select License Information.

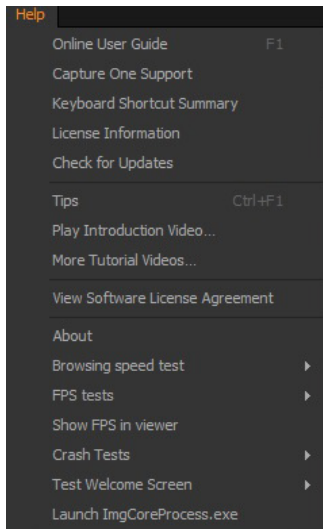

2. Fill in the License Activation form and click **Activate**.

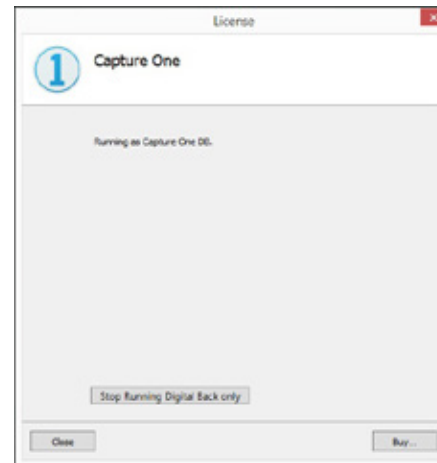

3. If current license is not as desired, press stop running current license.
The following message appears and Capture is closed.

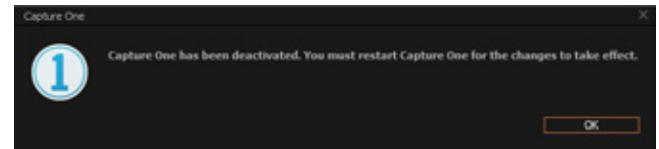

4. Relaunch Capture One and the following window appears:

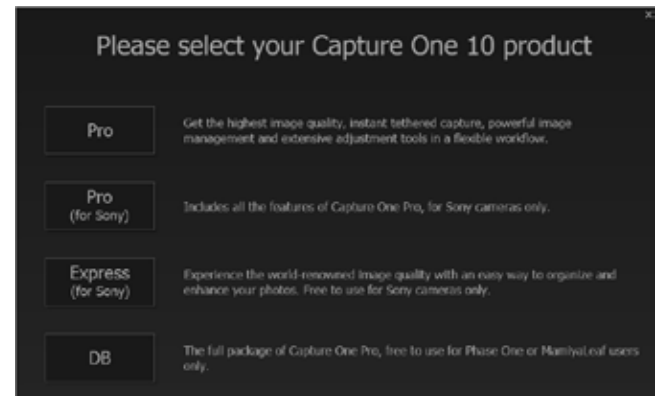

5. Select **Pro** or **DB**.

If **Pro** license is selected, the following window appears:

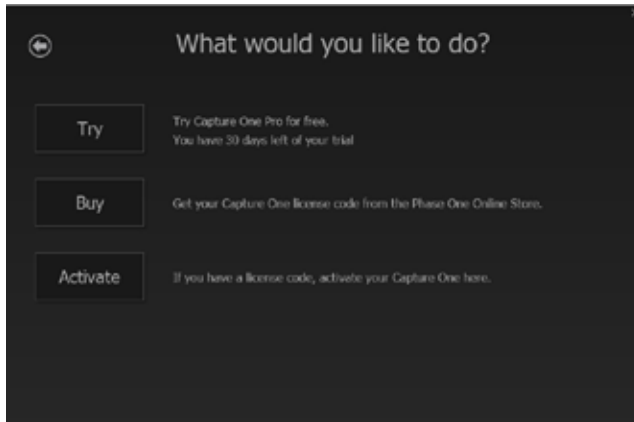

6. Press **Activate**

7. Fill in the License Activation form and click **Activate**.

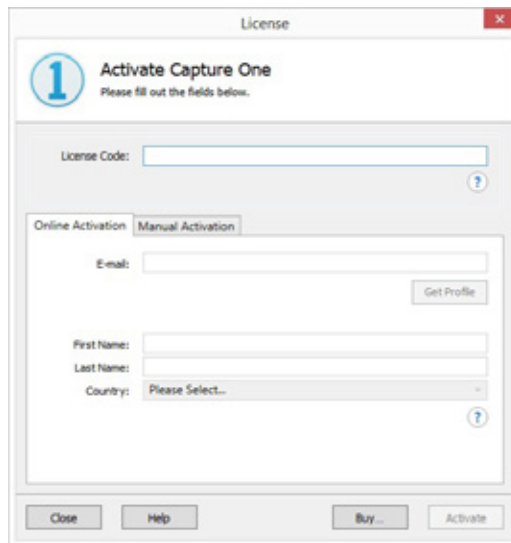

Starting a Tethered Session

To start a tethered session:

1. From the File menu, select New Session.

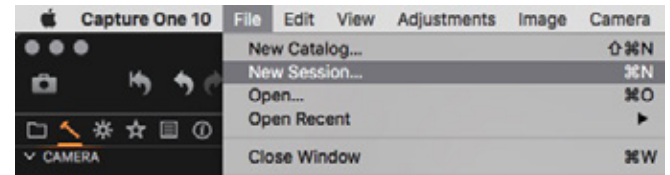

2. Fill in the information to customize your session.

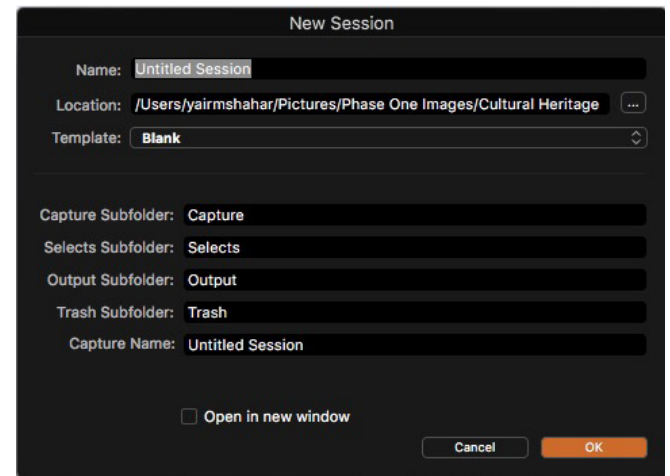

3. Click **OK** to start your session.

Selecting Next Capture Adjustments

In the Next Capture Adjustments section, configure the following:

- ICC Profile
- Orientation
- Metadata
- All Other
- Styles
- Auto Alignment

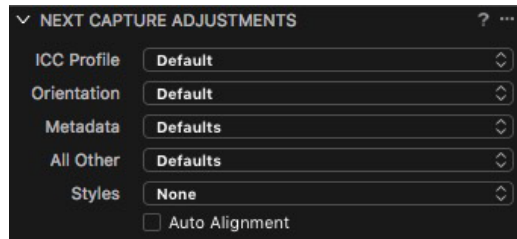

Selecting Camera Controls and Settings

In the Camera Controls Section, make selections for:

- Shutter speed
- Aperture
- ISO
- White Balance (from the list or manually)
- File Format (IIQ-L or IIQ-S)

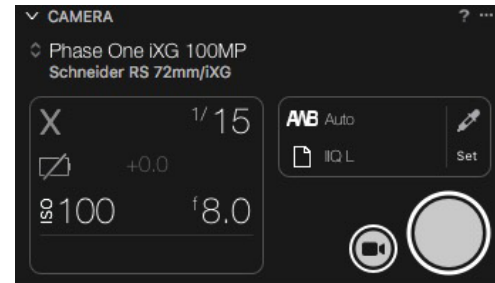

Working with Live View

To work with Live View:

1. Start a Tethered session as described above.
2. Choose Window > Live View or press the Live View icon . The Live View session starts.
3. Press RGB icon to switch between an RGB and a Black and White view.



4. Adjust Lightness and Quality as desired.

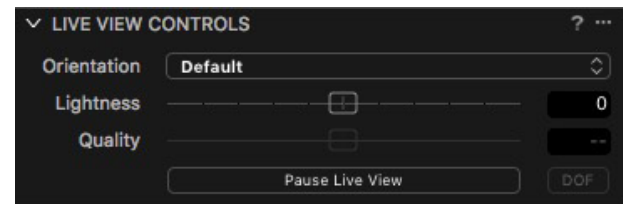

- Set White Balance using the White Balance picker (WB is only for Live View).



- Adjust the composition.
- In the Camera focus tool, click on the focus arrows to focus the camera's lens.

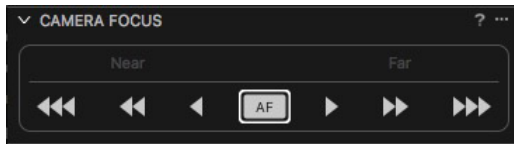

- Click single arrows for fine focusing and multiple arrows for medium or large focusing.

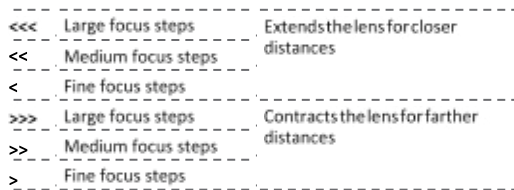

- To use Auto Focus, press the AF button.

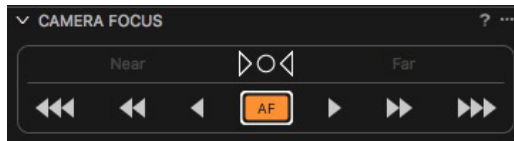

- A Focus Meter frame will appear in the center of the image preview, you can grab and move it to the area in the image that you wish to place focus on. The camera will automatically move the lens Up/Down until focus is achieved and the frame is shown in Orange.

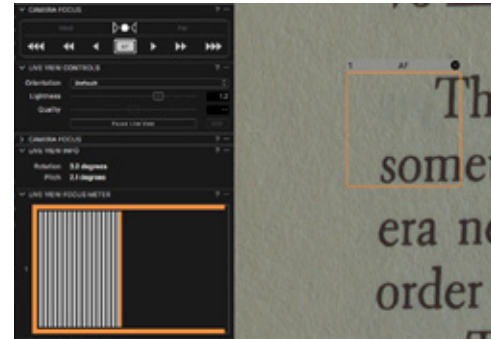

- To use Fine Auto Focus, press and hold the Alt Key and then press the AF button. The sign on the button will change and the camera will make small adjustments to focus.

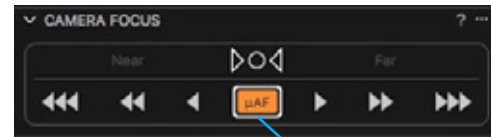

Fine Focus
AF Button

If the camera is already set to a close range from the focus plane, you can hold the Alt key and then press the AF button. The sign on the button changes to μ AF and the camera refocus by smaller focusing steps.

To set Fine Focus as the default mode, click on the "..." sign at the top right corner of the Camera Focus Tool and select AF Mode: Fine. The sign of the AF button changes as shown above.



Changing the
default mode
to Fine Focus

Note: For optimal results, reduce the Focus Meter frame's size and zoom in to 100% on the area of interest.

- Close the Live View window.

6. Capturing Images

This section describes the basic steps required for capturing images, optimized in terms of exposure resolution and sharpness. For more advanced instruction, please refer to Capture One's manual.

Shooting a Test Shot

To shoot a test shot:

1. Choose Camera.
2. Click Capture or press the Capture button in the Camera Tool.

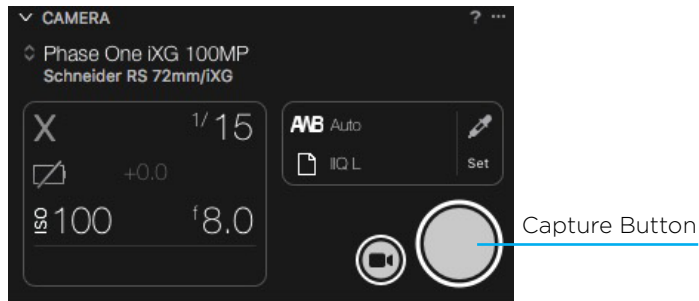

The image appears on your monitor.

Note: You can also trigger the camera by using the hand release or foot paddle units.

Evaluating Your Shot

To evaluate your shot:

1. Check your exposure with the histogram and picker tool.

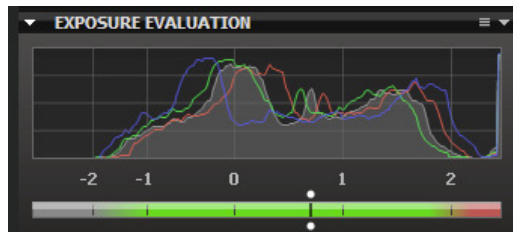

2. Check your exposure with the over-exposure and under-exposure warnings and make any necessary corrections. The following figure is an image with a warnings of white areas that are over exposed.

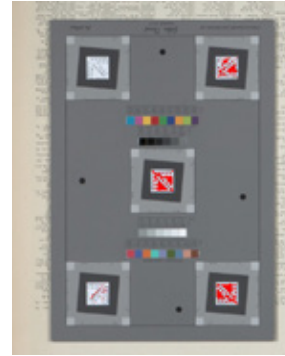

The following figure displays the Warning On/Off toggling option at the upper tool bar.



Note: At this stage it is recommended to use the zoom tool at 100% to check and confirm sharpness of the image.

Setting White Balance

To set the white balance:

1. Take a first shot of the Tethered session.
2. Click the White Balance icon in the Camera Tool.
3. Use the White Balance picker to set White Balance from a neutral area of an image file.



4. Click Set when the desired White Balance setting is achieved.

7. Video Display

The iXG camera is built with HDMI output capability, offering a choice of viewing the video feed on the camera's LCD or outputting to an external display. Follow the instructions below for working with the different video modes.

Activating HDMI Video Output

To configure the iXG video output:

1. Go to Menu > HDMI Video Output.



The HDMI Video Output screen appears.



2. From the HDMI Video Output screen, select On.

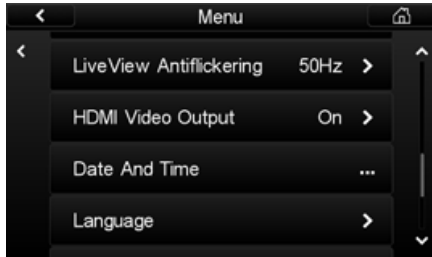

The Menu screen appears with **On** displayed.

3. Return to Home screen. LV changes to HDMI



Configuring HDMI Control

Before configuring HDMI control, HDMI video output must be activated. See "Activating HDMI Video Output".

The HDMI controls can be reached by clicking HDMI on the Home screen or in the contextual menu. Clicking the HDMI button starts the video streaming.

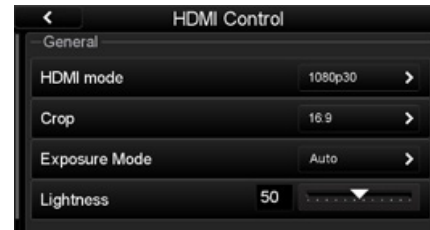

Configuring HDMI Mode

To configure the HDMI output:

Go to Home screen > HDMI > HDMI Mode.



The HDMI Mode screen appears.

Selecting HDMI Crop

To select the HDMI crop:

1. Go to Home > HDMI > Crop.

The Crop screen appears.

2. From the Crop screen, select one of the available crops:

- 16:9
- Full sensor 4:3
- Zoom 100%

The HDMI Control screen appears with your selection displayed.

Selecting Video Exposure Mode

To select the HDMI Exposure Mode:

1. Go to Home screen > HDMI > Exposure Mode.

The Exposure Mode screen appears.

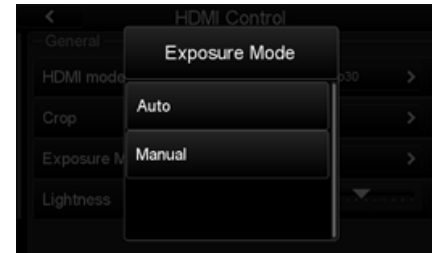

2. From the Exposure Mode screen, select either:

- Auto
- Manual

The HDMI Control screen appears with your selection displayed.

Note: If Auto is selected, follow the instructions in “Adjusting Lightness” below.

If Manual is selected, follow the instructions in [TBD](#) to achieve an optimum balance for display.

Adjusting Lightness

The HDMI output can be changed to be lighter or darker.

To adjust the lightness:

1. Go to Home screen > HDMI.

The **HDMI Control** screen appears.

2. Adjust the lightness by dragging your finger along the lightness scale (0 to 100) and viewing the results on your external display.

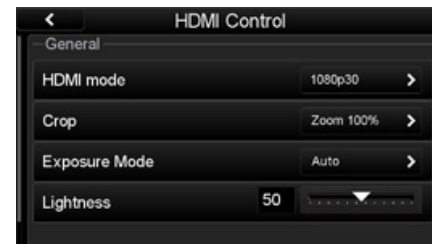

Adjusting ISO

When using Manual Mode, the sensitivity can be raised or lowered to produce different results on your monitor.

To adjust the ISO:

1. Go to Home screen > HDMI > ISO.

The **ISO** screen appears.



2. Select a desired ISO. (50 to 12,800).

The **HDMI Control** screen appears with your selection displayed.



Adjusting Exposure Time

When using Manual Mode for video, the exposure time can be adjusted to produce different results on your monitor.

To Adjust Exposure Time:

1. Go to Home screen > HDMI > Exposure Time.

The **Exposure Time** screen appears.

An asterisk appears next to the suggested exposure time, which is based on the HDMI Mode that was previously selected.



2. Select a desired exposure time.

The **HDMI Control** screen appears with your selection displayed.



8. Firmware Handling

The display on the back of the iXG camera back can displays technical information about the hardware and embedded firmware of both the camera body and back. This is especially useful if support is needed or if you want to check if Phase One is offering a newer firmware update.

Please make a note of the firmware menu contents before contacting your dealer or Phase One Support.

Checking the Camera Firmware Version

To determine if you have the latest camera firmware installed:

1. Go to Menu > About System.



2. Check to see if the firmware version installed on the camera is the same as the latest version available in the Downloads section of industrial.phaseone.com website.



About the Phase One Firmware Updater Application

The Phase One Firmware Updater application is used to update your Phase One iXG camera with new firmware. The Firmware Updater for Mac or Windows is available at the Downloads section of the industrial.phaseone.com website.

The Firmware Updater does not in itself contain any firmware—it detects the camera attached, checks online for the latest firmware and retrieves and installs the firmware packages for your device.

Installing the Firmware Updater Application

Download the Firmware Updater from the Downloads section of the industrial.phaseone.com website and follow the appropriate installation instructions below:

Mac

To install the Firmware Updater on a Mac:

1. Open the zip file and copy the Firmware Updater application to your Applications folder.
2. Double-click the icon to start the Firmware Updater Setup Wizard.

Windows

1. Open the zip file and store the FWUpdater.msi.
2. Double-click FWUpdater.msi to start the Firmware Updater Setup Wizard.
3. When installation completes, click Start > Phase One > Firmware Updater.

Updating the iXG Camera Firmware

Steps for updating are the same on both Mac and Windows — screenshots come from the Mac version

Before starting, ensure that:

- The camera is powered ON.
- USB 3.0 is connected to the back and to the computer.
- Your computer has the Firmware Updater application installed and the computer is connected to the Internet.

To update the iXG Firmware:

1. Start the Firmware Updater application.
2. The Firmware Updater automatically checks online for a new version of camera firmware and displays a download button if your camera requires an update.
3. If displayed, click the link to download the firmware. The firmware is saved locally.

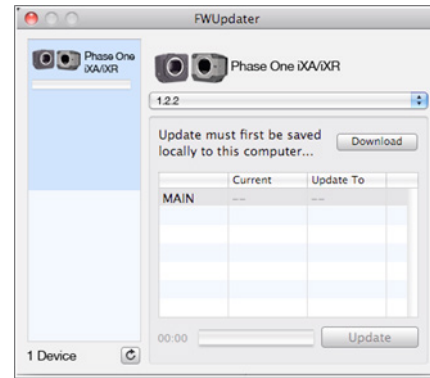

4. After downloading the new firmware, the download button becomes a Release Notes button.

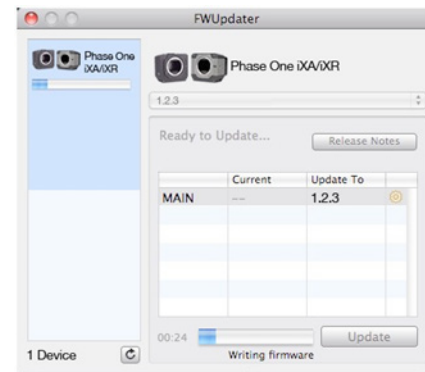

5. Click the Release Notes button to download the release notes for the newest firmware.

- To update the camera to the latest firmware, click Update. The firmware is written to the camera and a cog icon  is displayed next to the MAIN component and a progress bar displays the progress of the update.
- Upon a successful completion of the update, the MAIN component is marked with a green check mark icon.
- If the update fails, disconnect both the USB and the cables and reconnect them again, then repeat the procedure described above.
- Select Update Firmware from the Firmware menu and the back automatically detects and implements the update from the card.

A progress bar appears on screen during installation.

Restoring the iXG Camera Firmware

In the event you need to restore the camera's firmware to the factory version.

- Go to Menu.



- Select Restore Firmware.
The original firmware is installed.
- Click the check sign to approve.

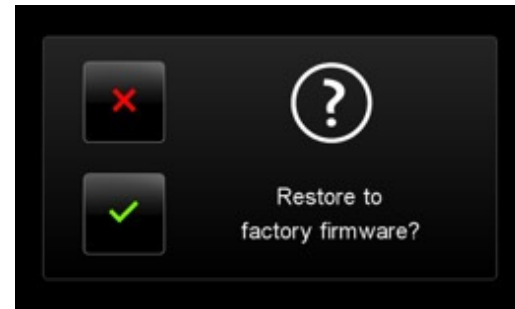

The original firmware is installed.

PHASE**ONE**
INDUSTRIAL

Visit the website for additional information
www.phaseone.com